

**9.484**  
 PESO TCO: 0.605  
 PTRO. TOTAL: 0.33  
 PTRO. EXT.: 0.17

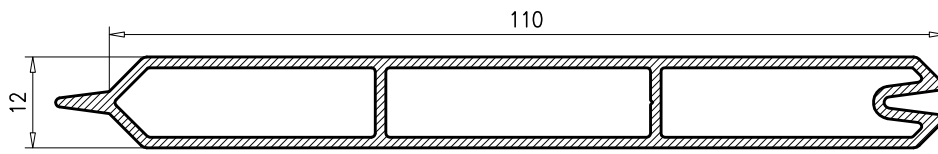

**7.992**  
 PESO TCO: 1.026  
 PTRO. TOTAL: 0.53  
 PTRO. EXT.: 0.26

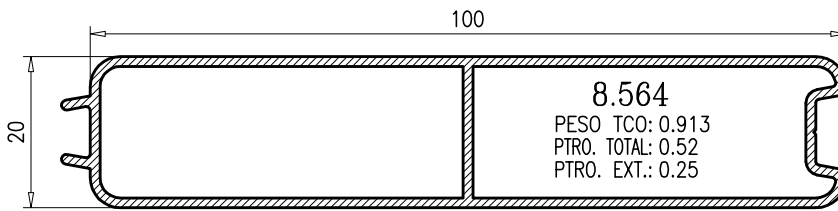

**8.564**  
 PESO TCO: 0.913  
 PTRO. TOTAL: 0.52  
 PTRO. EXT.: 0.25

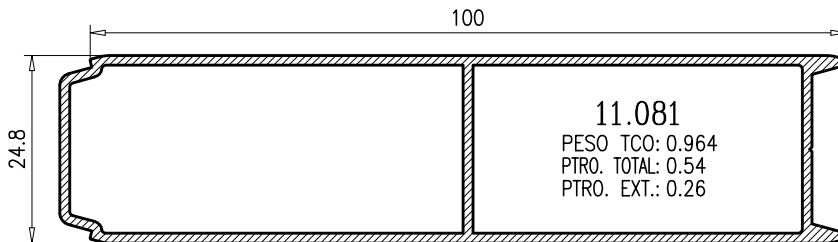

**11.081**  
 PESO TCO: 0.964  
 PTRO. TOTAL: 0.54  
 PTRO. EXT.: 0.26

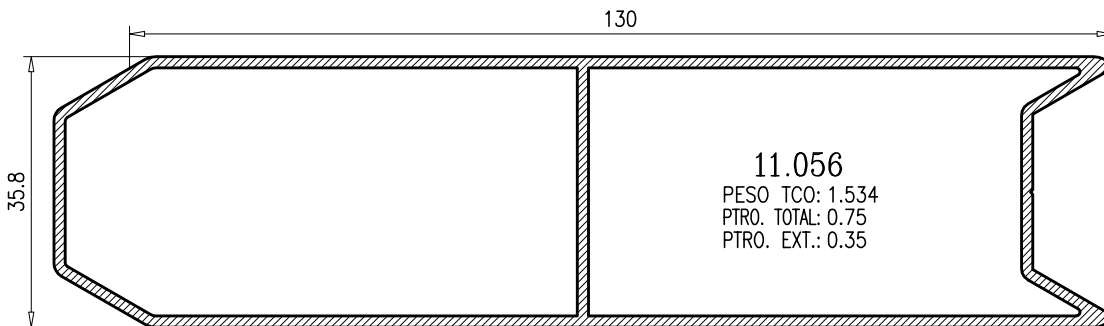

**11.056**  
 PESO TCO: 1.534  
 PTRO. TOTAL: 0.75  
 PTRO. EXT.: 0.35

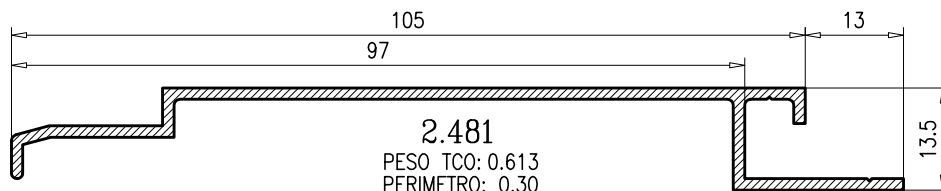

**2.481**  
 PESO TCO: 0.613  
 PERIMETRO: 0.30

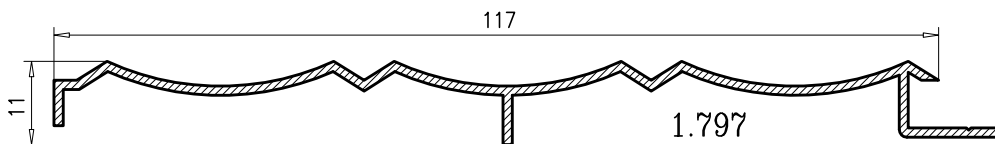

**1.797**  
 PESO TCO: 0.500  
 PERIMETRO: 0.31

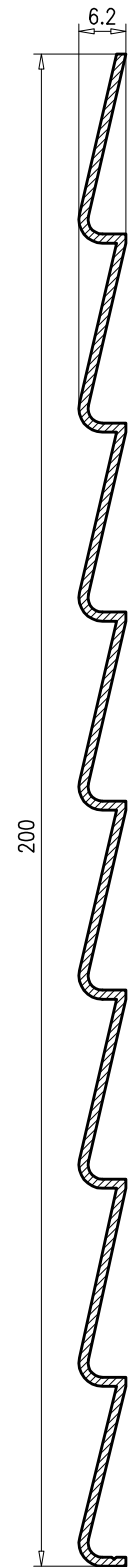

**4.020**  
 PESO TCO: 0.891  
 PERIMETRO: 0.47

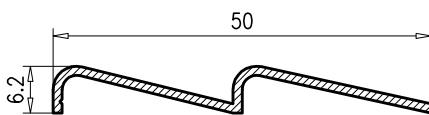

**4.018**  
 PESO TCO: 0.208  
 PERIMETRO: 0.12

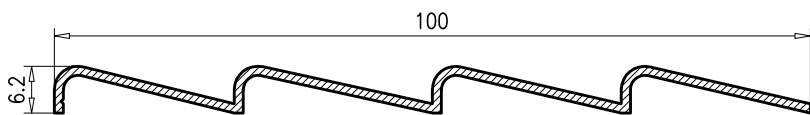

**4.019**  
 PESO TCO: 0.431  
 PERIMETRO: 0.24